

# LED

## Linear High Bay



LED RAYS  
MASTERING LIGHT

### LHB IL Series

NEW

### Features

- Integrated Linear LED High Bay Luminaire
- Featuring Bridgelux™ or Nichia™ LED
- >120lm/w Efficacy for SO Version & 140lm/w for HO
- Six Beam Distribution Options with Integrated Lensing
- Available in 1x, 2x, 3x, 4x & 6x Docking Configurations
- IP65-67 Ingress Protection, Harsh Environment Capable
- Digital Drivers with 4 Way Protection
- AL6061 Aluminium Housing for Great Thermal Performance
- >105,000hrs L70 at 25°C Ambient

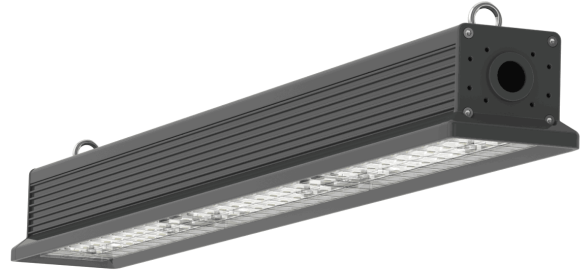

### Product Features



Bridgelux™ or Nichia™ LED

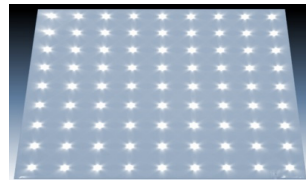

Hi Efficiency MCPCB Design

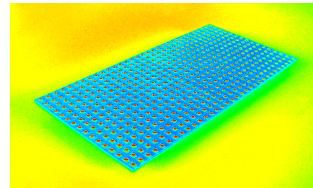

Exceptional Thermal Performance



Digital Driver with 4 Way protection



AL6061 Extrusion

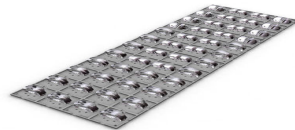

Fully CAD LENS Structure System



Suspension Mounting System



Input JB/Stainless Hardware

### Electrical Specifications

1. Power Input: AC100-277V
2. AC180-528V (Option)
3. Power Factor:  $\geq 96$
4. THD:  $\leq 15\%$  @ full Load
5. Dimming/Sensors: Yes optional



MEPi

www.ledrays.com

## Product Specifications

Model	Power	LED Type	CCT	Efficacy	Luminous Flux	CRI	Beam Angle	IP Level
LR-LHB-IL040EW-SO	40W	MEPI™	3500-6500K	≥120lm/W	4800lm	80-85	30°/60°/90°/120°/30°x90°/25°ZT	IP55
LR-LHB-IL080EW-SO	80W	MEPI™	3500-6500K	≥120lm/W	9600lm	80-85	30°/60°/90°/120°/30°x90°/25°ZT	IP65-67
LR-LHB-IL100EW-SO	100W	MEPI™	3500-6500K	≥120lm/W	12000lm	80-85	30°/60°/90°/120°/30°x90°/25°ZT	IP65-67
LR-LHB-IL100EW-HO	100W	MEPI™	3500-6500K	≥140lm/W	14000lm	80-85	30°/60°/90°/120°/30°x90°/25°ZT	IP65-67
LR-LHB-IL160EW-SO	160W	MEPI™	3500-6500K	≥120lm/W	19200lm	80-85	30°/60°/90°/120°/30°x90°/25°ZT	IP65-67
LR-LHB-IL160EW-HO	160W	MEPI™	3500-6500K	≥140lm/W	22400lm	80-85	30°/60°/90°/120°/30°x90°/25°ZT	IP65-67
LR-LHB-IL200EW-SO	200W	MEPI™	3500-6500K	≥120lm/W	24000lm	80-85	30°/60°/90°/120°/30°x90°/25°ZT	IP65-67
LR-LHB-IL240EW-SO	240W	MEPI™	3500-6500K	≥120lm/W	28800lm	80-85	30°/60°/90°/120°/30°x90°/25°ZT	IP65-67

## ORDERING CODE: LR-LHB-IL100EW-SO-90-1X-XX-XX-XX

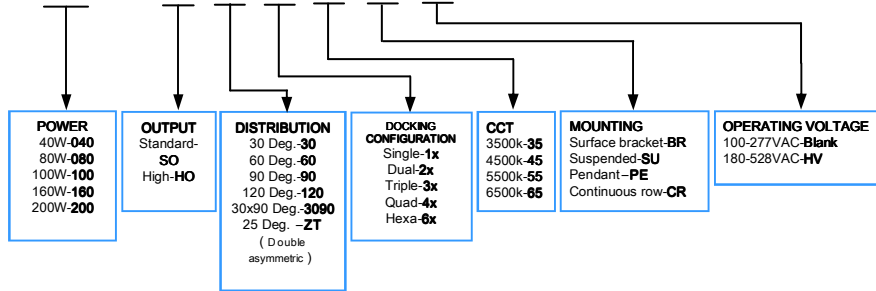

## DISTRIBUTION CURVES

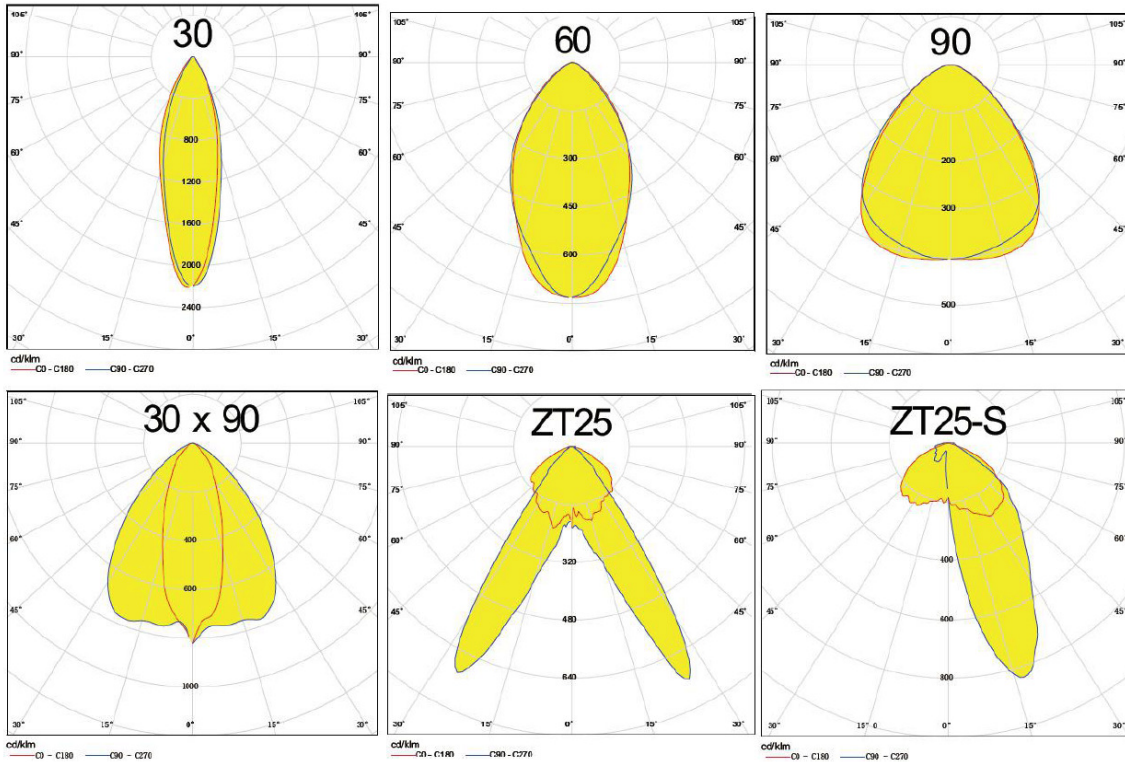

## Product Specifications

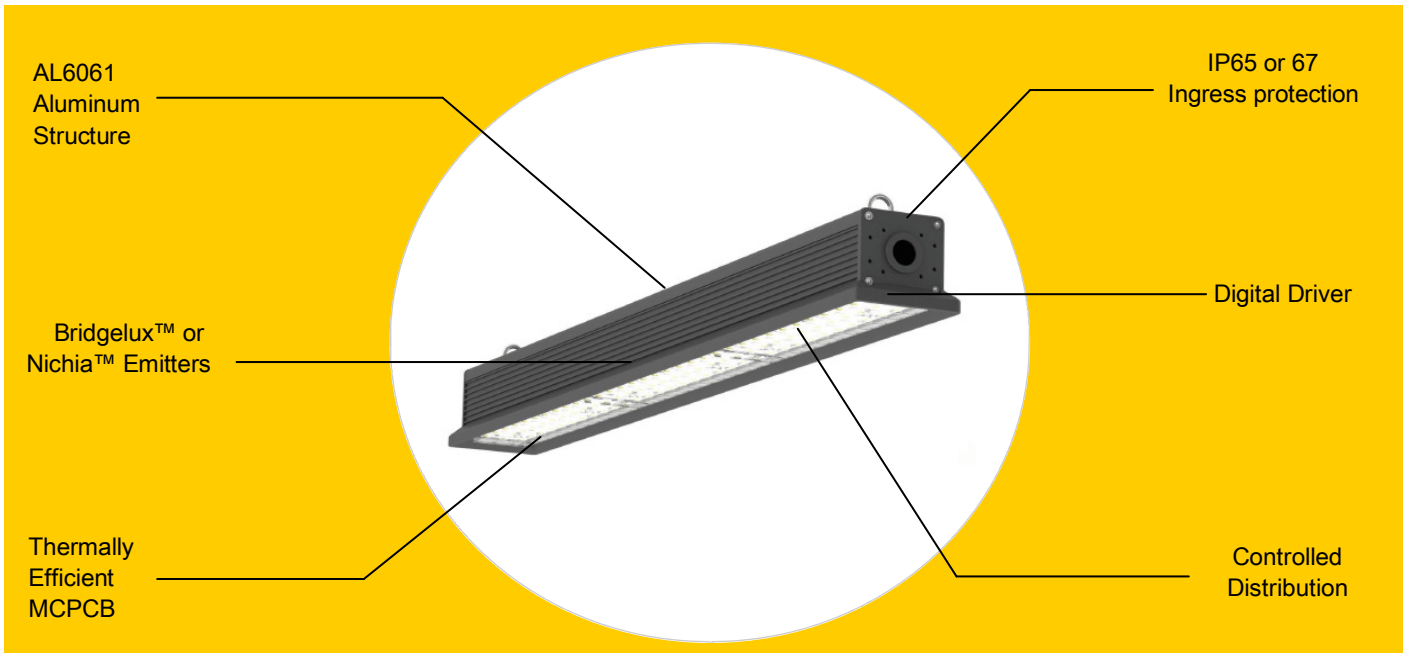

## Dimensions:

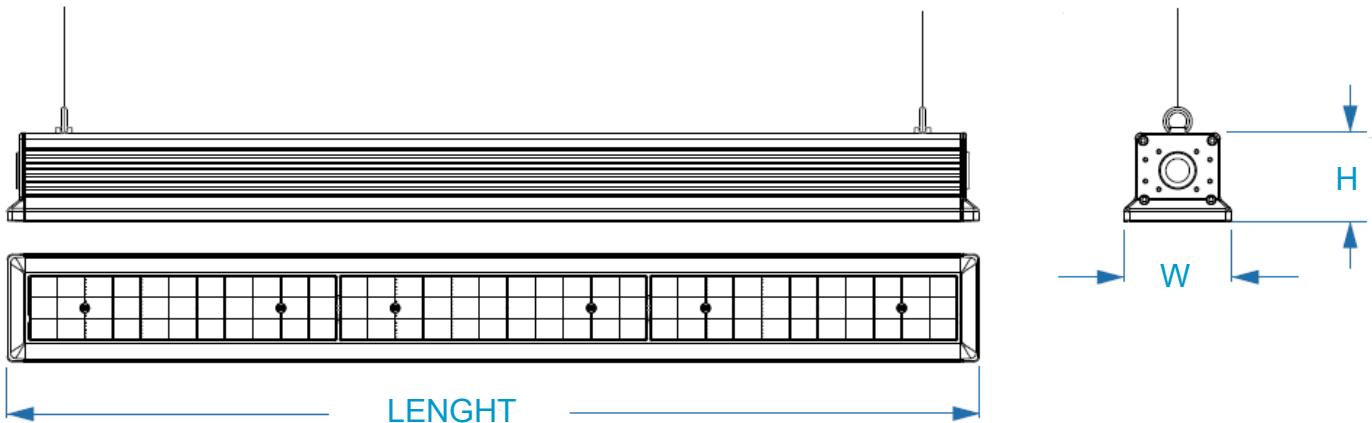

Model	Length mm	Width mm	Height mm	Weight kg
LR-LHB-IL040EW-SO	331	100	82	2.2kg/4.85lbs
LR-LHB-IL080EW-SO	618	100	82	3.0kg/6.60lbs
LR-LHB-IL100EW-SO	905	100	82	4.4kg/9.68lbs
LR-LHB-IL160EW-SO	1192	100	82	5.5kg/12.1lbs
LR-LHB-IL200EW-SO	1497	100	82	6.8kg/14.96lbs
LR-LHB-IL240EW-SO	1784	100	82	8.1kg/17.82lbs

The specifications in this brochure are representative and must not be interpreted as a guarantee of individual product performance and/or characteristics. LEDRAYS Inc. has a policy of continuous advancements & development specifications may change without notice. Please contact your rep for updates.

**LUMIA**AGENCY